



# Eurobodalla Branch Newsletter



**January - March 2012  
Number 2012-1**

[www.ulyssesclub.org/branches/eurobodalla/](http://www.ulyssesclub.org/branches/eurobodalla/)

## What's in this issue?

Office Holders	2
Office Holder Reports	4
What's happening in our Branch?	10
Victoria Creek Princes Highway upgrade	14
Bikes on the Net	16
BMW Concept e Scooter 2011	16
Oral.M3 - yet another Moto3 engine	18
World's smallest V-12 working engine	19
Vic Pol reignites identification debate	19
Those who support us	22

## Office holders



President: Jim Chaplin  
(02) 4474-2837  
chaplin70@internode.on.net

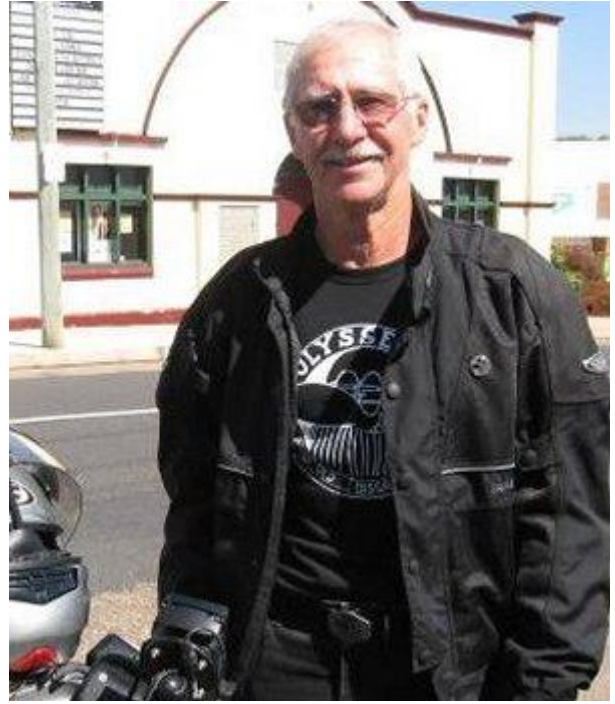

Secretary/Treasurer: Frank Hopkins  
(02) 4473-5422  
frankhopkins e@bigpond.com



Social Secretary: Chris Zammit  
(02) 4474-2448  
chris.zammit@steeline.com.au



Quartermaster: Murray Osborne  
0418-472-302  
go2momo@dodo.com.au

Continued next page...



Ride-Coordinator and  
Webmaster: Robert Overdijk  
(02) 4474-4110  
overdijk@bigpond.com



Committee member: Helen Jenkins  
(02) 4473-6868  
lhjenkins@aapt.net.au



Welfare Officer: Neil Adams  
(02) 4476-7679  
doctorgo@bigpond.com



Newsletter Editor: Peter Anderson  
(02) 4472-2274 or 0458-13-95-95  
peterjohnanderson@gmail.com

# Office holder reports

## The President's Message

Hi everyone, well that's another year 'done and dusted' - what happened to 2011? Maybe that old saying is correct "the older you get, the faster the years go" do you think that's correct? Maybe it's true, but I'd rather subscribe to old Albert Einstein's - 'the theory of relativity' - which states that "time passes more slowly for a faster moving object than it does for an object at rest". You can't argue that a motorbike is a faster moving object than most other objects around the place; so the advice is to not sit around getting prematurely old, but to seize the moment, cram as much in as possible and stay younger for longer. A couple of examples from our own mob spring to mind (and there are sure to be more) Sam Smith, smile on his face and back on the Yamaha, and Doc Adams back on the Spyder; it really does work.

The branch Christmas party was hosted this year by Chris and Jenny Zammit. What a great occasion it was; their hospitality was enjoyed by a good mix of old and new members and even the storm and downpour that happened just as we lit the barbecue couldn't dampen the festivities. Frank and the ladies enjoyed the dance floor and the 60's music - a great night and a beaut "bacon and eggs" morning the next day. We farewelled old friends Lyell and Helen Jenkins, off on their next life adventure to Cootamundra.

And that's what Ulysses did; the only difference being that Lyell took his Penelope with him.  
**Good luck mate.**

I am writing this just a couple of days out from Christmas, you will probably be reading it just after, or in the new year. I hope every one of you has/had a Merry Christmas and a Happy New Year.

Jim Chaplin #38825

## Secretary/Treasurer's Report

I will take this opportunity to remind those members having membership expiring 31/12/11 (like myself) to renew in time.

You will be aware that I have been forwarding emails concerning the recovery of Neil "Doc" and Fay Adams as I have received them from their daughter, Bindi. Doc is back on his Spyder and decided to withdraw it from sale. Fay is recovering well and they both expect to visit their home at Dalmeny on regular occasions in the New Year. We wish them well and hope to see them at Saturday coffee, etc.

To assist in the replacement of Secretary/Treasurer as I intend to do more caravanning in the future and not be in a position to respond to requests in a timely fashion from the National Office or members. I am prepared to continue as Treasurer 'as I will need the money to travel' (only joking). The financial statement can be kept up to date without any urgency and the Quartermaster can keep cheques, and bank monies in my absence.

It is common for many of the Branches to have separate Secretaries and Treasurers. This may assist in finding a replacement Secretary, but if someone wishes to perform either or both roles don't hesitate to submit an application for the Committee. Forms will be sent out in the New Year well in advance of the Branch AGM in April.

The financial year with all Branches ends on 31 December and GST payable is sent to the National Club who pay the GST for the Ulysses Club as a whole. In the past we have not been subject to an

official audit and earlier this year we were sent information that an audit would be required in the future. As you know this can be a costly exercise and objections were raised by many Branches. The outcome is that an official audit is not now required but the Balance Sheet and associated invoices and banking records, etc. will be reviewed by a panel consisting of the President, Branch Secretary and one other member, not being the Treasurer. (Not sure how it works when the Secretary and Treasurer is combined.)

Our IMB account balance for the end of November was \$1221.12 and we have stock to the value of \$368.00.

All the Best for Christmas and the New Year.

Frank Hopkins

## Social Committee's Report

Social activities as a group, in the last few months, have been well attended with the main event being the Christmas party early in December.

The day started out as a fine warm day and then, as it has in past years, turned a bit wet and cool. No problem just get undercover and have a good time in the shed as we have done in past years. The dance floor was a bit on the small side but that didn't stop the keen ones from doing their thing. See photos for evidence of this being the case.

Quite a few decided to stay the night and camped in the back yard and there were a number who came back for the Sunday breakfast. Sunday breakfast lasted to late morning as everyone was enjoying the time together just socialising. All in all a very social event was enjoyed by those who attended.



*Lyal and Helen at the Xmas Party*

The party was also an opportunity for the group to express their gratitude to Helen and Lyell Jenkins for all their efforts over the years in their roles as President and Social committee member as well as their tireless efforts in organising social events. A framed collection of photos, which was put together by Robert was presented to Helen and Lyell. Very well put together by Rob which was a collection of moments where Helen and Lyell were enjoying being

out on the various bikes they have and do own.

I would like to personally thank Helen in all her efforts in assisting me with the organising of the social activities over the past few years and she will be missed for her ability to arrange the food for these type of events.

The next quarter's social activity sees a Branch BBQ at Mystery bay which was around the same time as last years BBQ there. As Rob mentioned in the ride calendar,bring your swimmers. The water may be a bit on the cool side but if the day is warm then it is a good place for a dip to cool off.

Anyway looking forward to the next years fun to be had and thank you to all who attend the social events,it makes it all worthwhile to see people enjoying themselves.

Regards,  
Chris Zammit

## Ride coordinator and Webmaster's report

Another year nearly over or by the time you read this it will be 2012. I have only been able to get on maybe 30% of the rides myself but from feedback received most of the rides have been well attended. It remains difficult to come up with different rides as we only have 3 directions and 3 roads to start every trip.

Ideas on rides from our members are always much appreciated.

By chance, David Lovie met up with Kevin Gibson at the Bermagui vintage rally earlier this year, who has a great car collection at Ulladulla and invited our Branch to visit.

This ride turned out to be one of the best attended rides this year on Sunday 13th November. Kevin and his wife Sandra offered great hospitality with home baked cakes and biscuits and viewing of their collection. The soft top and sedan Auburns were fabulous, especially after seeing the photos of the condition of the sedan when it was found. The very rare Flanders was another fine example of how to restore a car to better than new condition. Afterwards we rode on to Huskinson for lunch at the bakery and finished off the ride with a coffee stop in Burrill Lake before heading home.





A few weeks earlier a large number from the Eurobodalla Branch made the annual pilgrimage to the Snowy Ride. Another 3100+ riders again turned up for this event raising funds for childhood cancer research. This year being the 10th year in a row for myself.



The Friday afternoon ride to Charlottes Pass was as always a pleasant ride, great scenery, together with great weather. Still enough snow left for Di and June to put on a snow ballet, which drew a

small crowd. On Saturday our first stop was Dalgety, then on to the various other stops before returning to Jindabyne. A few of us went for another ride to Charlottes Pass and then to Thredbo for the draw and presentation.

The next ride calendar has a BBQ at Mystery Bay on 22nd January, a ride to Canberra on 12th February to see a large bike and car collection of Peter and Ann Toet and various other rides with the finale, the AGM at Mildura at the end of March, something for everyone.

All the best wishes for the New Year.

Robert Overdijk

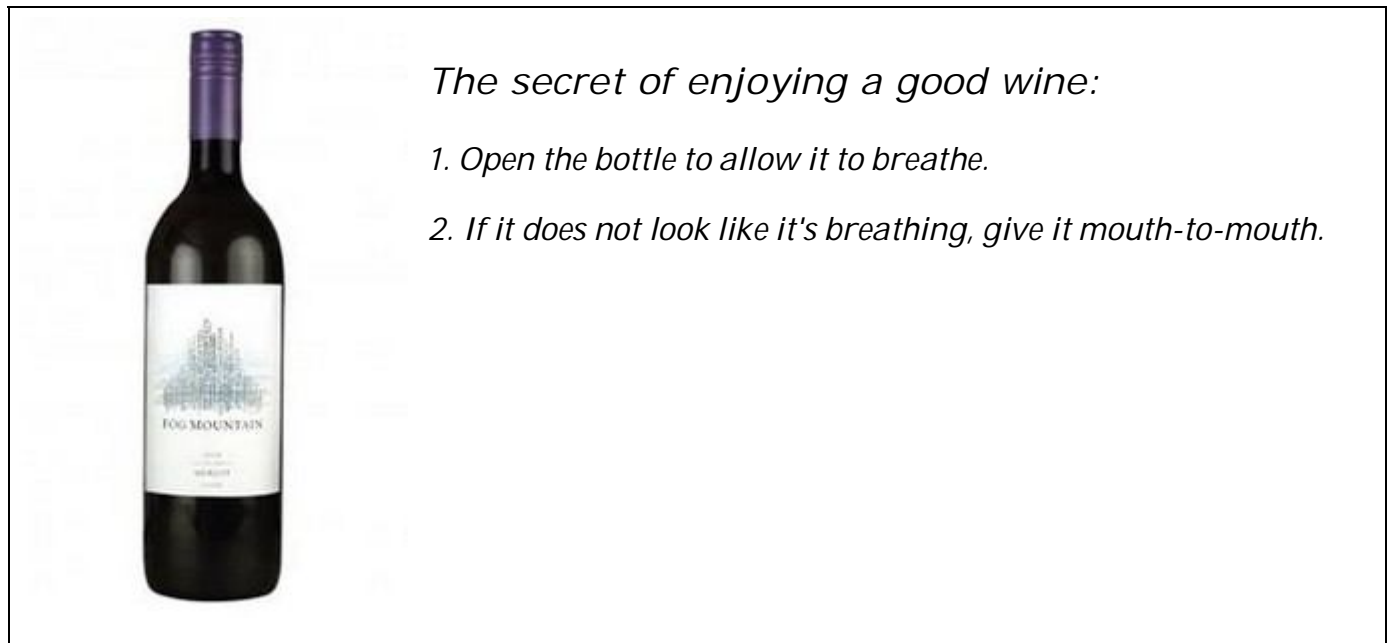

## Editors ramblings

It's almost the end of the year and I'm just about finished my eighth Newsletter and yet again, I am running late. Well at least I have a good excuse this time — Bev and I were in France from late October to late December. It's a week and a half since we got home and except for a Wednesday off to have a ride on my bike its been all go at the Anderson household; what with Xmas and family and friends, lawns to be mown and to top it off a bloody "Mexican" ran into my car four days after arriving home — he thought that the Beach Road and Glenella Road intersection was a round-about and continued straight-on into the side of my car as I turned right towards the Bay 🤔. "I was confused", he said, "We don't have roundabouts in Victoria!" "Its NOT a bloody roundabout you bl\*dy idiot!" I retorted. Ah! well, the insurance will have it all fixed by mid January. In the meantime, I'll have to dink Bev to the shops on the back of the Kawasaki 😊.

I wanted to talk about our trip from a motorcycling perspective. Here are a few observations:

Our trip included ten days in Paris, eight days in Florence (including a one day trip to Rome) and the rest of the time touring with a small village called La Cadriere d'Azur (50 km east of Marseille) as our base. The touring included lots of motorway travel, many cities, towns and villages and some truly frightening narrow country roads. All up we covered about 5,500 km.

## Scooters

You see lots of scooters in all built-up areas but very few on the motorways; those you do see tend to be Maxi scooters like the Yamaha T-max. In larger towns and cities scooters are wall-to-wall. I

drove through the centre of Florence and they just come at you from all directions; they don't keep to lanes and often they don't keep to their side of the road.



*Scooters in Florence*

In peak hour type traffic they lane-split at quite high speeds. They turn on their hazard flashers and just rip through the lanes of slower cars, often changing three or four lanes as they go. It all looks quite chaotic but nobody ever seems to have a crash. In Paris and Marseille they ride with BOTH feet trailing along the road! It just seems so dangerous.

Kids can get a restricted licence at about fifteen or sixteen; they can only ride a motorcycle/scooter with an engine of less than 50 cc. These bikes all seem to be two strokes and almost everyone has been "hotted-up" with very sinuous and very loud expansion chambers - you can hear them screaming through the narrow streets of towns and villages.

## Motorcycles

You see about one motorcycle for every fifty or more scooters. Some die-hard riders use their bikes to ride to work and back but most seem to be kept for the weekend. Its the type of bikes you see that is interesting; most tend to be super-sports or sporty naked bikes. There are very few cruiser style bikes and when you do see one its probably a Harley Davidson 😞. The sports bikes tend to be ridden very fast and with no care to what might be coming in the opposite direction.

Paris is quite different to any other city we visited; the bike you see most there is the Honda Goldwing! They seem to be extremely popular with many ridden all week and really large numbers on the roads over weekends. On our last day, as we drove out to the airport at 7:30 in the morning, we must have been passed by twenty or thirty Goldwings during the 40 km drive. BMW touring bikes, on the other hand, are quite rare and more often than not are police motorcycles.

That's enough prattling on for now. As I write this it is too late to wish you all a merry Xmas but I will wish you and your families a good and very safe 2012. Keep an eye on the Ride Calendar as we are going to try a few two and three day mid-week rides in 2012 and I hope you can join me on some of them.

Regards,  
Peter Anderson #48070

# What's happening in our Branch?

## Saturday morning coffee ride



The Branch organises an enjoyable soiree each Saturday morning for a short ride (for those whose bikes don't get out much), stimulating conversation (on subjects such as the differences in valve stem guides between the 1975 and 1976 BMW R-90 - fascinating) and good coffee (tea or Bonox is optional). These pleasant get togethers alternate between:

- First Saturday of the month: Bodalla Bakery, Bodalla
- Second Saturday of the month: By the Beach Bakery, Lilli Pilli
- Third Saturday of the month: Bodalla Bakery, Bodalla
- Fourth Saturday of the month: By the Beach Bakery, Lilli Pilli
- Fifth Saturday of the month: Bakehouse Batemans Bay

Come along for a pleasant morning with your fellow members. If you are a prospective member this is a great way to "try before you buy".



### *Engineers?*

*Calvin Rickson, an engineer from Texas A&M University, has designed a bra that keeps women's breasts from jiggling, bouncing up and down and prevents nipples from pushing through the fabric when cold weather sets in.*

*After a news conference announcing the invention, a large group of men took Mr. Rickson outside and kicked the shit out of him.*

## Wednesday rides



If you find yourself at a loose end any Wednesday morning consider coming for a ride. Mid-week is often a much more pleasant time for a ride than over the weekend; there is not as much traffic and the destinations tend to be much less crowded. Ride destinations are published on the Ride Calendar but because numbers are often small there is some scope for variation. If you want to know more contact Peter Anderson on (02) 4472-2274 or 0458-13-95-95.

## The Branch has a Welfare Officer

Neil 'Doc' Adams is the Branch's Welfare Officer. He asked that this small piece be included in the Newsletter so that members know he's there if needed.

"I am available if needed for any matter that might require the help of some body wearing the label 'welfare officer'. It might be the case that, since we are all pretty independant and self sufficient buggers, we don't like to ask for help when it might be needed. So I might ask that if any of us does know of a fellow member who might be in need of a bit of support of some kind, but would never ask for it himself, they might let me know and I'll try to make an appropriate offer or approach. Although it may not be relevant to my current role, I should mention that I spent quite a few years as a counsellor, including drug counselling and marriage guidance counselling."

Regards, Doc

### *Biker Humour*

*A drunken man walks into a biker bar, sits down at the bar and orders a drink. Looking around, he sees three men sitting at a corner table. He gets up, staggers to the table, leans over, looks the biggest, meanest, biker in the face and says: "I went by your grandma's house today and I saw her in the hallway buck naked. Man, she is one fine looking woman!"*

*The biker looks at him and doesn't say a word. His buddies are confused, because he is one bad biker and would fight at the drop of a hat.*

*The drunk leans on the table again and says: "I got it on with your grandma and she is good, the best I ever had!"*

Continued next page...

*The biker's buddies are starting to get really mad, but the biker still says nothing.*

*The drunk leans on the table one more time and says: "I'll tell you something else, boy, Your grandma liked it!"*

*At this point the biker stands up, takes the drunk by the shoulders, looks him square in the eyes and says: "Grandpa! Go home! You're drunk!"*

A blast from our past...

PHONE (02) 4472 6577 THURSDAY NOVEMBER 25, 2004

## Ulysses would be pleased with his 21st century namesakes

YES, Santa does ride a motorcycle. And he's going to be riding along the Princes Highway on December 4 collecting toys and donations for needy children and adults in the shire.

The Eurobodalla branch of the Ulysses Club has a membership of motorcyclists dedicated to fundraising for local charities. The national body was formed in 1983 and since then branches and membership have boomed with motorcyclists aged over 50 (junior members accepted from age 40) who are determined to remain young at heart and grow old disgracefully.

Now renowned for their nationwide fundraising efforts, in particular for the Arthritis Research Taskforce, each branch also gives a helping hand to their local charities.

Every Christmas the Eurobodalla Ulysses members embark on a Charity and Toy Ride from Batemans Bay to Narooma. In conjunction with the ride, members will be busy running a monster raffle - with 22 prizes - and collecting toys and donations of money and non-perishable goods beforehand.

At 11am on December 4, motorcyclists of all ages are invited to gather in the parking area opposite big Woolies in the Bay for the start of the trip south through Mogo, Moruya and Bodalla before arriving at O'Briens Hotel in Narooma for a giant sausage sizzle at 1pm.

Eurobodalla Ulysses branch president Hans Ottevaenger said the public was most welcome to attend the sausage sizzle.

Along the way, vehicles of the four-wheeled variety will collect toys and goods.

At Narooma the Eurobodalla contingent will be met by their Bega/Eden and South Coast counterparts who have travelled north on the same mission.

Hans said all proceeds from the ride and raffle would be given to St Vincent de Paul at Narooma and from there distributed to other charities in the shire.

Keep an eye out for Hans on Friday and Saturday this week and next week opposite the Post Office in Batemans Bay. He will be selling raffle tickets and accepting goods for needy people in the shire.

Goods and donations can be dropped into Capital Coast Cycles at 36 Princes Highway, Batemans Bay, where raffle tickets are also available. Bikeworx in Campbell Parade is taking money donations only.

Ring Hans on 4472 3543 for more information.

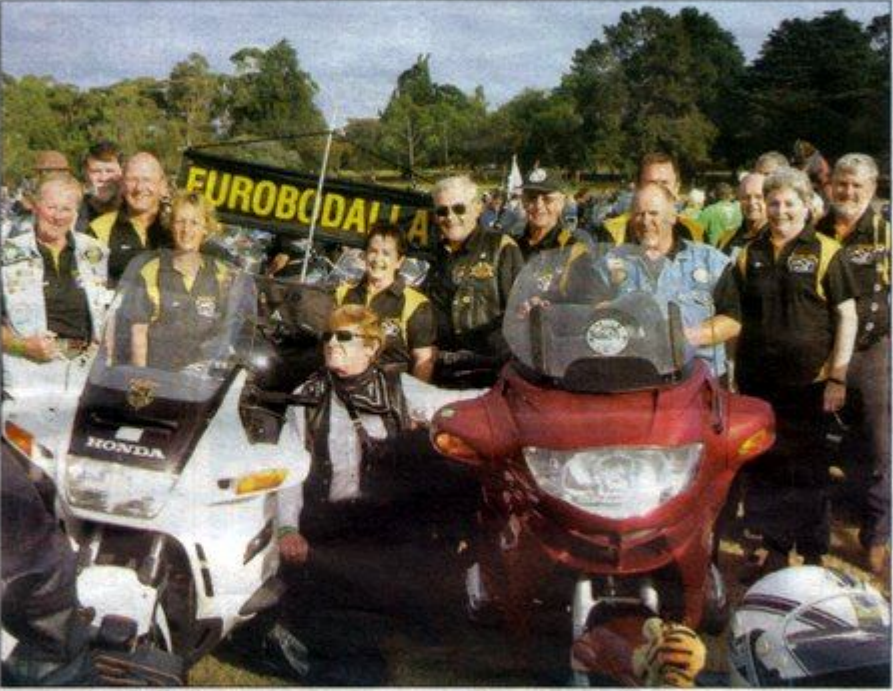

**MODERN-DAY HEROES:** Eurobodalla Ulysses Club members are gearing up for their annual Charity and Toy Ride on December 4.

Des Ayers our rarely seen member from out west near Cootamundra sent this newspaper clip from 2004. A few familiar faces are recognisable.

Thank you Des. If you have any old photos you would like to share send a copy to the Editor.

Above and beyond the call of duty...



Who said being "Ride Co-ordinator" was an easy job. Here we have proof that at times it can get rather tiring.

Next time you want to "slag-off" the Committee, remember the effort they put in for you 😊😊.

# Victoria Creek Princes Highway upgrade

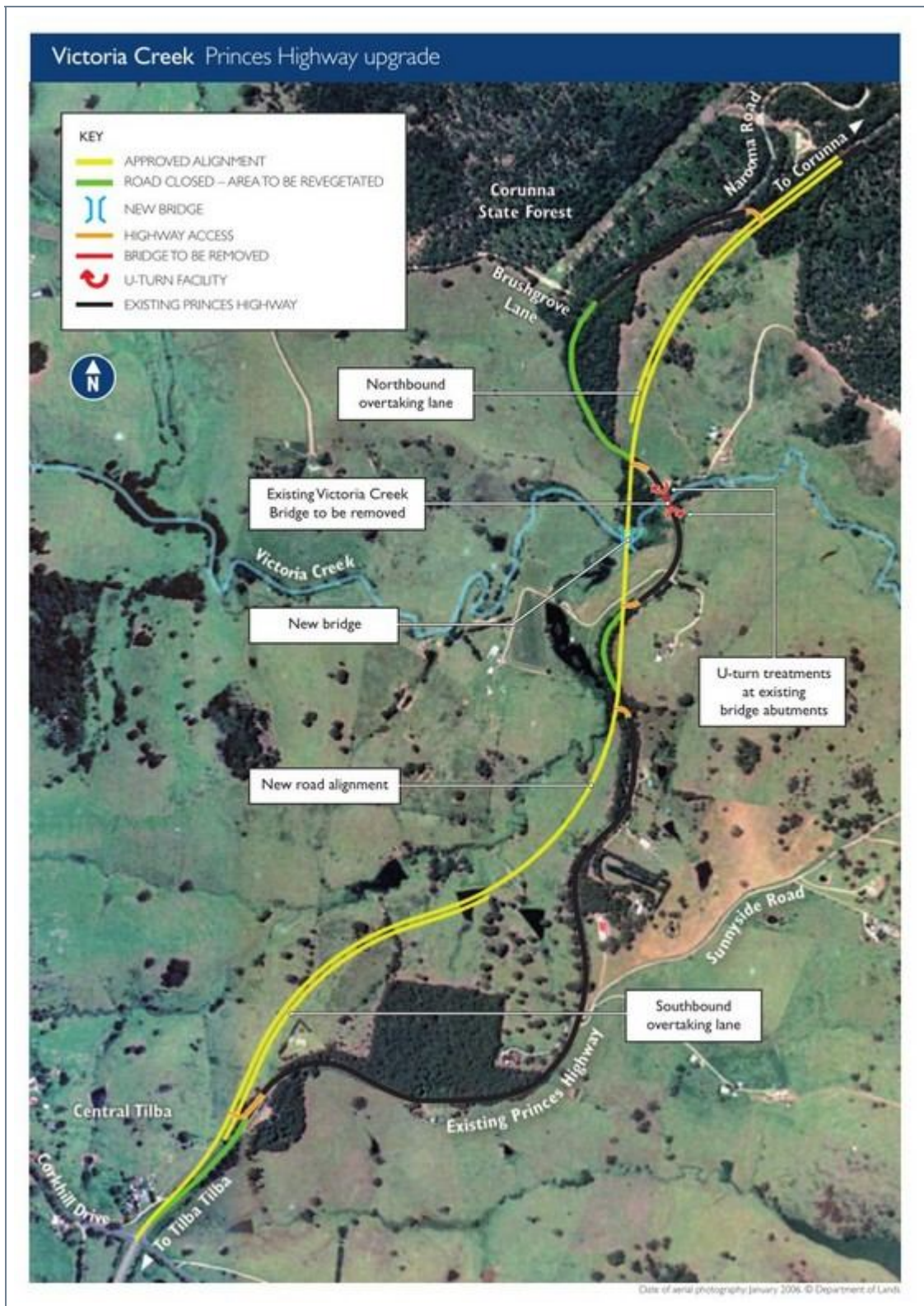

On a recent mid-week ride south we were held up by the extensive roadworks just north of the Tilba turn off. As we crawled through the road work speed restriction zone it was obvious that the work being undertaken was going to be quite significant. I made a mental note to look up the Internet when I got home that evening to see what was being done. The extent of the road works turned out to be quite significant; the whole of the old windy and narrow road section of the Princes Highway either side of Victoria Creek (I had not known it was called Victoria Creek) was to be replaced with a majestic swoop from the northern side of the Victoria Creek valley, down across the Creek itself (via a new bridge) and then a matching sweep up the southern side of the valley to join with the existing up-graded highway just north of the Tilba turn off. These road

works will match the scale of the recently completed "Bendalong Bends" project. More details of the Victoria Creek project follow.

The NSW RTA provides a PDF download explaining the extent of the Victoria Creek up-grade; and I quote from that document.

## Background

The Princes Highway between Narooma Road (the Old Princes Highway) and Central Tilba will be upgraded. As part of this work the existing bridge at Victoria Creek will be replaced. This will improve road safety along this stretch of road.

This section of the Princes Highway is a winding stretch of road with a history of vehicle crashes. Most of these crashes involve vehicles leaving the road on curves. The upgrade will eliminate the tight curves on this section of the Princes Highway.



## The project

The RTA will be upgrading the Princes Highway with a new 3.2 kilometre stretch of road.

The key features of this project are:

- An overtaking opportunity will be provided for motorists in both directions.
- A new bridge will be constructed on the new alignment of the Princes Highway.
- The current bridge over Victoria Creek will be removed, with provision of cul-de-sacs on each side of the road.
- Parts of the existing highway will be retained as local access roads.
- Other sections of the existing highway will be reclaimed as bushland and will be rehabilitated by the RTA.

The RTA expects the work to be completed by mid-2013. An arial photo showing the extent of the project follows on the next page.

06' Suzuki GSXR 1000

Fourways, Johannesburg

This bike is perfect! Only done 7000 kms and has had its 1500 km. dealer service. No falls/scratches. I use it as a cruiser/commuter. I'm selling it because it was purchased without proper consent of a loving wife. Apparently "do whatever the fuck you want" doesn't mean what I thought.

Call me, Steve. (011) 867-8292

[EMAIL THE SELLER](#) [SELLER'S WEBSITE](#) [ADD](#) [PRINT](#) [CLOSE](#)

## Bikes on the Net

This section of the Newsletter will report on motorcycling things of interest that have been seen on the Internet. If your browsing comes across anything you feel might be of interest please send the URL to the editor.

### BMW Concept e Scooter 2011

The design study BMW Concept e embodies the vision of an electrically powered scooter made by BMW. Increasing limitations in traffic space, growing traffic density as well as both ecological and economical challenges give rise to new demands in the area of private transport in the major conurbation areas in particular. An e-scooter with sustainable technological solutions and the aesthetic design of the Concept e provides a response to these changing urban mobility needs. (From [www.dieselstation.com](http://www.dieselstation.com))



"The Concept e is a vision: BMW Motorrad designers have developed the style and shaping of the e-scooter of the future — electric, digital, dynamic. The designers deliberately allowed themselves plenty of freedom so as to be able to strike out new, creative paths in the design of components and surfaces.

So the design concept study Concept e is more than just an idea for a new vehicle. In addition to technical functionality and quality, the BMW Motorrad designers attach importance to an emotional dialogue between rider and vehicle. Their basic premise is that a vehicle has to do more than just function — it has to arouse the rider's emotions, too. It has to inspire the rider again and again, as well as reflect its specific technological features.

The Concept e is the conceptual blueprint of a scooter able to set new standards with innovative premium electrical drive and provide a sound alternative form of mobility suitable for everyday

use in the dense traffic of the constantly expanding conurbation areas and cities of the world today." (From the online BMW Motorcycle Magazine [bmwmcmag.com](http://bmwmcmag.com))



While we are talking about BMW motor scooters the new C600 Sport and C650GT models have begun production.



BMW in Berlin recently opened assembly lines for the start of production of two new maxi C600 Sport and C650 GT scooters. About three years of development time and a total investment of €35 million. It will take 30 employees assemble the scooter. The new production line for this ambitious project will allow a volume of up to 116 vehicles per day. For 2012, BMW is forecasting the production of 10,000 vehicles. The twin-cylinder engine in both models is completely new and produces 44 kW. The technical basis of the two brothers is the same, the differences are mainly aesthetic, in different load capacity and ergonomics. (From [www.motoblog.it](http://www.motoblog.it))

## Gift Idea. Knuckle Meat Pounder!



It's probably a little late to include this potential present but you might like to keep it in mind for next year.

To match your bike knuckle levers or shifter handle, a menacing knuckle meat pounder for her or for him, not to fight in the kitchen but to flatten your food or your steak.

This metal meat tenderiser makes the job easier and way more fun. 4 1/3"H x 2"W x 2 3/4"D.

May or may not be legal in your jurisdiction, so remember to keep it in the kitchen. Okay?

US\$12.95 at What On Earth Catalog  
([www.whatonearthcatalog.com](http://www.whatonearthcatalog.com)).

## Oral.M3 - yet another Moto3 engine

Recap: Moto3 is the replacement formula for the 125 cc two-stroke class that has been a support category for MotoGP and its predecessors for many years. Moto3 is a 250 cc four-stroke single cylinder based class that begins racing in the 2012 season. The interest of this class is its basically free design; it will be the place where new techniques in automotive engine design are released and publicly tested over coming years.

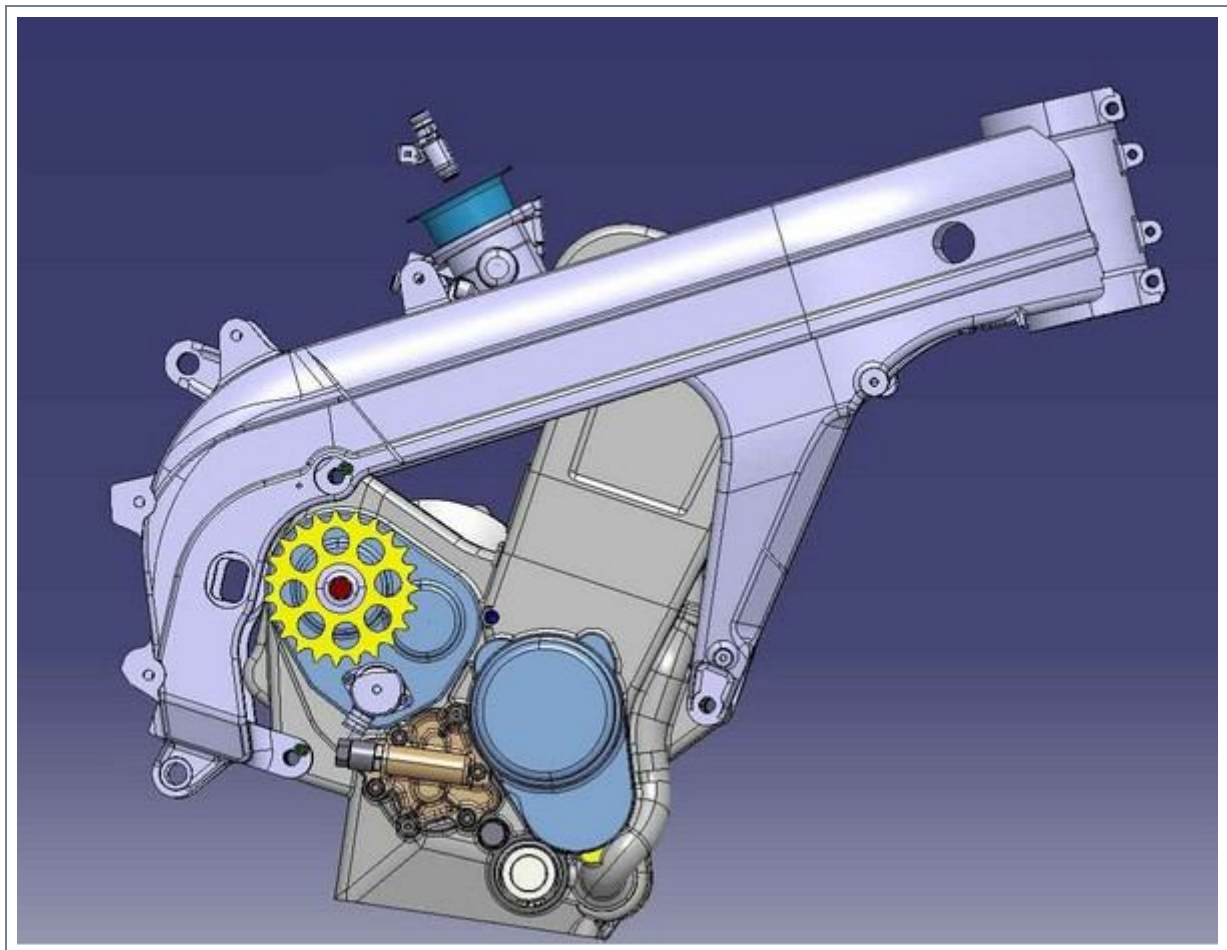

Oral.M3 is a Modena, Italy based organisation that has developed a rather novel new engine for the Moto3 category. The engine is extremely compact and weighs less than 11 kg (about the same

size and weight as an out-going 125 cc engine. The new engine, code named OE-250M3R, has been specifically designed to fit the existing Aprilia GP125 frame and cycle parts with very minor modifications. This engine will save an existing Aprilia entrant approximately 80% of the cost of a bike for the new class as they can continue to use their existing chassis and gearbox and use the racing setup data they have accumulated over previous seasons.

Moto3 is certainly going to be an interesting class to watch.

## World's smallest V-12 working engine



A Spanish craftsman named Patelo skillfully designed and fabricated this tiny working V-12 motor from stock stainless steel, aluminum, and bronze. It took more than 1200 hours of work. Not counting the 222 screws, he machined all 261 pieces himself. The engine operates via compressed-air injection, has 12 cc total displacement, 11.3 mm long cylinder heads, and a 10 mm stroke on each piston.

If you are interested there is a video of this engine on YouTube - see [http://www.youtube.com/watch?v=3YfTtGCsiD8&feature=player\\_embedded](http://www.youtube.com/watch?v=3YfTtGCsiD8&feature=player_embedded)

## Vic Pol reignites identification debate

It's on again... The Victorian Police has recommended, in a submission to an enquiry into motorcycle safety, compulsory front identification.

The Victorian police claims that, in 2010, 49 per cent of all motorcycles caught speeding through fixed and mobile cameras in the state could not be identified. In raw numbers, that equates to 10,800 riders which the police believes escaped fines.

Those statistics form the backbone of a police submission, released under the authority of Deputy Commissioner Kieran Walshe, to a Victorian parliamentary enquiry into motorcycle safety, which calls for compulsory front identification on bikes.

"The identification of all motor vehicles, including motorcycles both from the front and rear, will assist in reductions in speed and speed-related road trauma," the report said.

There has been an immediate reaction to the police submission. Prominent motorcycle advocate Marcus Wigan was on the front foot this morning, telling listeners on top rating radio station 3AW that he was "entertained" by the police statistics.

"I am always entertained by the way the police manage to produce statistics that don't seem to line up with experience elsewhere," he said. "When I did a speed camera study for VicRoads in 2001, it had 703 car violations without front number and identification and 1044 for motorcycles. In South Australia it was similar sort of ratio."

"These figures are so out of line with the experience of 10 years ago that it is something that I'd like to go and check. This a very interesting shift."

"There are only three jurisdictions where front number plates are still allowed, let alone mandated."

Kieran Walshe responded to Wigan's comments: "With due respect to the Professor's research, it was 10 years ago. We do have a vast increase in the number of fixed and mobile speed cameras (most of which seem to be pointing in the **WRONG** direction - Ed.) operating in the state and our date for 2010 is very clear."

Meanwhile, the police submission to the enquiry has also called for riders being forced, by law, to wear five pieces of protective clothing such as a helmet, jacket, pants, gloves and boots. At the moment only a helmet is mandatory.

This represents a policy shift, with former Deputy Commissioner Ken Lay not a champion of the blanket mandate.

"Our intelligence continues to show that a lack of protective clothing continues to be a key factor in road trauma involving motorcycles," the submission said. "While in the past we have maintained a strong push in encouraging riders to always wear full safety gear, we have now taken the next step and asked that consideration be given to the mandatory wearing of protective clothing and a national standard for this equipment."

The parliamentary inquiry continues, with the last two days set aside for public hearings. The final report will be tabled in state parliament in June, 2012.

*From: [www.bikepoint.com.au](http://www.bikepoint.com.au)*

This is a typical "Yes Minister" ploy—introduce two controversial issues at the same time (front number plates and the new protective clothing requirement) and hope to divide and conquer the opposition. At best you get both initiatives up but getting the long-term revenue-raising one up is just as good, after all, its the main game. *Editor*

Something nice to finish on...



*Ritmo Sereno BMW R100RS*

In the mid-70s, the BMW R100RS was the most radical motorcycle you could buy. It was BMW's answer to the relentless threat of large-capacity Japanese motorcycles, and it came with a seven-part fairing—a new style of bodywork that reportedly reduced side wind deflection by 60% over the standard S model. But it looked a little ungainly, and sales were unspectacular. This custom, however, does justice to BMW's original vision—some 35 years later. This one is from Ritmo Sereno, the Japanese resto-mod specialist.



*Ritmo Sereno BMW R100RS*

# Those who support us

## LetzScoot

- Sales, hire and service
- Unique showroom
- Full range of accessories
- Tires and electronic balancing
- Mechanical repairs to all makes
- Road-side assist

Unit 1, 16 Kylie Cres. Batemans Bay  
(02) 4472-6223 or 0439-727-717  
[www.letscoot.com.au](http://www.letscoot.com.au)

LetzScoot offers Eurobodalla Ulysses Branch members a 10% discount on accessories

## Mick Cole Motorcycles

Authorised dealers for Honda, Yamaha and Suzuki

Eurobodalla Branch members are offered a 10% discount on accessories and some parts.  
Remember to present your membership card before payment.

14 Ridge St., North Bega  
(02) 6492-3122  
[www.mickcolemotorcycles.com.au](http://www.mickcolemotorcycles.com.au)

## Canberra Motorcycle Centre

We offer a 15% discount on accessories to Ulysses members on presentation of their card.  
Conditions apply - savings off original prices, excludes some special orders.

### **Fyshwick**

Cnr. Isa & Newcastle Streets  
(02) 6280-4491

### **Mitchell**

26-28 Kembla Court  
(02) 6241-8107

## Nowra Motorcycles

Sales and service for: Honda, Triumph, Husqvarna and Hyosung motorcycles.

Offers a 10% discount for Ulysses members on motorcycle service, spares and accessories.

132 Princes Highway, South Nowra  
Call: (02) 4422-9681  
E-mail: [nowramotorcycles@bigpond.com](mailto:nowramotorcycles@bigpond.com)

Continued next page...

# Great Southern Motorcycles

Suzuki and Kawasaki

Offers a 10% discount for Ulysses members on motorcycle accessories.

188 Princes Highway, South Nowra

Phone: (02) 4422-8889

E-mail: [sales@greatsouthernmotorcycles.com.au](mailto:sales@greatsouthernmotorcycles.com.au)